

# 高清高速球型网络摄像机

**KEDACOM**

快速安装指南

Quick Start Guide



## 前言

感谢您购买我司产品，如对本公司产品有疑问或需要，请随时和我们联系。我们尽最大努力来保证本手册信息的正确性，如因升级等原因发生信息修改，恕不另行通知。

获取最新文档请联系产品供应商。

## 安全说明

此手册的目的是确保用户正确使用本产品，以避免危险或财产损失。在使用产品之前，请认真阅读此手册并妥善保存以备日后参考。如果用户因没有按照以下安全说明，致使设备不能正常使用或损坏等情况，责任由用户承担。

- 请使用满足安全电压要求的电源，电源供电要求为AC24V/2.5A。
- 如果设备工作不正常，请联系厂家或最近的服务中心。不要以任何方式随意拆卸或修改设备。
- 请勿将任何物品摔落到设备上或强烈敲击设备。
- 清洁镜头时，须使用吹气球或专业镜头布除去镜头上的污垢。清洁透明球罩时，须使用足够柔软、干燥的布擦拭，切勿使用含酒精、苯等清洁剂洗涤。
- 避免将摄像机对准强光（如灯光照明、太阳光等处）聚焦，否则容易引起过亮或漏光现象（这并非摄像机故障）也将影响摄像机寿命。
- 避免将产品暴露在非用户手册所示的工作环境下使用。
- 使用时不可让水或任何液体流入摄像机。
- 当运送摄像机时，请重新以出厂时的包装进行包装，或用同等品质的材质包装。
- 需要替换部件时，请事先与经销商联系，更换指定型号的部件，或与原部件具有相同特性的部件。擅自使用其它部件进行替换，后果自负。

## 防水

- 室外安装推荐使用支架横臂有一定向上角度的壁装支架。
- 用户自选支架安装推荐使用接口为内螺纹的支架，同时须确保支架的防水性能；用户自选支架安装若选用外螺纹支架，须确保支架与球机连接的转接器件的防水性能。
- 安装时螺纹口需缠绕生料带，并确保螺纹密封；安装时对准螺纹，不能出现明显偏位及滑丝。
- 球机透明球罩上的密封胶圈必须安装，防止水蒸气及灰尘进入设备。

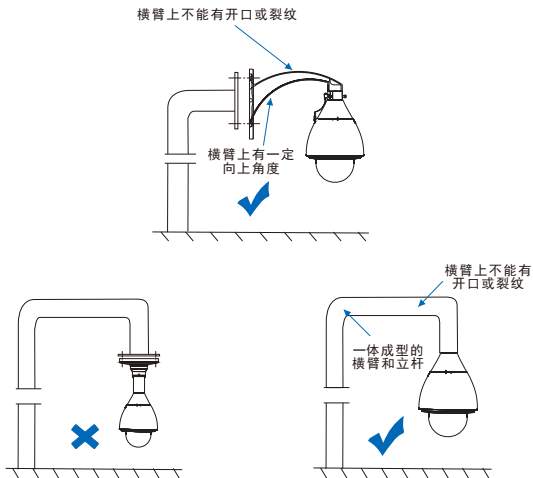

## 防静电、防干扰、防雷、防浪涌

- IPC安装不进行接地可能会因为静电造成电子器件损坏。
- 在雷电多发地区，需要对IPC进行就近接地，释放雷击等高能能量，防止IPC损坏。
- 在电压不稳地区，需要对IPC进行接地，释放浪涌等高能量，防止IPC电源烧坏。
- IPC安装防雷接地线不能替代安全接地线。在采用接地不良的立杆，如木杆、水泥杆，需要安装安全接地线，泄放漏电流以确保IPC或立杆不引起安全事故。
- IPC安装防雷接地线不能借用附近的其他电子设备接地线入大地，必须单独接地。

### 【水泥杆接地】

水泥杆方式需要配置钢管护套用于接地线穿管，如图所示，球机接地线从钢管内部穿过接地。控制中心本地进行规范接地即可。

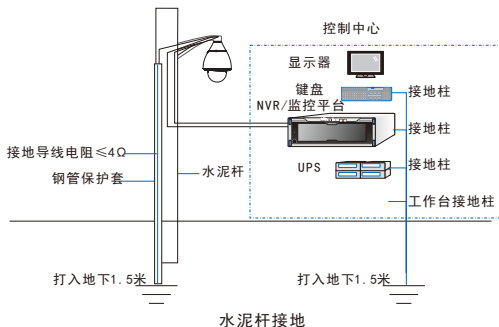

### 【金属杆接地】

金属杆方式采取PVC管穿接地线。没有安装避雷针的金属立杆，采用接地线（穿PVC管套）靠近金属杆的位置固定后实施接地，如图所示。

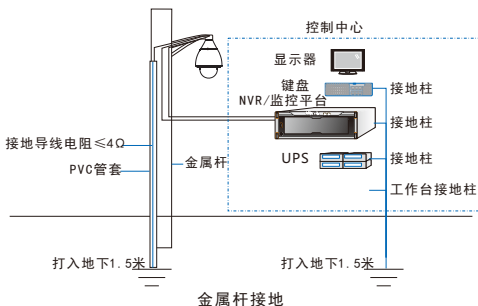

安装了避雷针的金属杆，采用金属杆内穿接地线（穿PVC管）的方式接地，且PVC管需要与金属杆内壁保持尽量大的绝缘距离，如图所示。

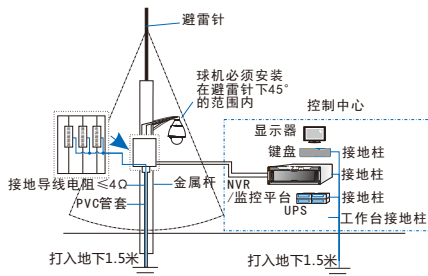

**【注意】**如果IPC传输过程中使用了光端机或者防雷器等中间件，需确保中间件接地良好，同时需确保IPC的连接线缆通过中间件也能接地良好。

**【说明】**务必按照本说明书所示安装步骤进行安装，若自行操作导致安装不当，责任由用户承担。  
**安装检查**

安装球机前，须对安装墙面/天花板进行安装强度检查。

- 墙壁/天花板厚度可支持安装膨胀螺钉。
- 墙壁/天花板可承受8倍球机加支架等附件的总重量（室外球最大净重：4.5Kg；室内球最大净重：2.1Kg）。

### 室外球准备

1. 打开球机透明罩，取出防震泡棉，撕掉保护贴纸，按需安装SD卡：



**【说明】**部分型号SD卡槽位置与图示略有不同，根据实际情况安装。

2. 套上球机透明罩，并拧紧螺钉固定。

**【注意】**下球罩容易划伤，请在安装步骤全部完成之后再撕去表面的保护膜。



## 其他支架安装

装配转接件步骤参照壁装支架。

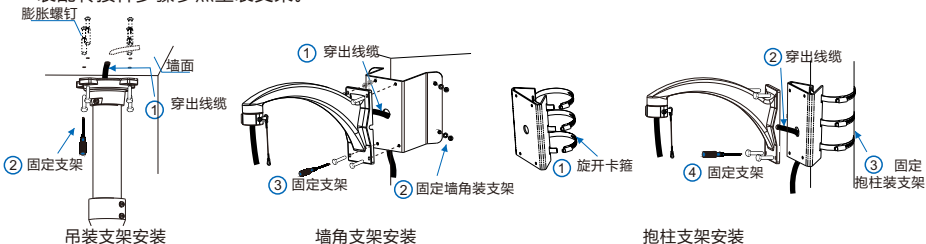

【说明】支架均为选配配件。

## 室外球安装

1. 拧开对开式防护罩上螺钉，按标签指示方向旋转，再向相反方向掰开对开式防护罩；

【说明】对开式防护罩内有防坠绳与球机相连，后续安装图示仅作为示意图。



2. 先将支架上的安全挂钩另一端挂扣到球机上，线缆穿过上球罩；球机安装柄的D字直边对准转接件上的标签后，将球机上推进转接件底部并旋转180°至黄色标签对齐，此时球机已固定。最后锁紧两颗防脱螺钉。

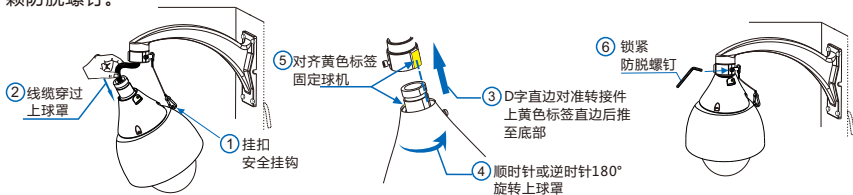



3. 拧开上球罩上两颗固定螺钉，打开上球罩；



4. 按照球罩内所贴标签连接线缆，连接完成后检查并整理各类线缆，然后用绝缘胶布缠绕牢固，做好避水弯；

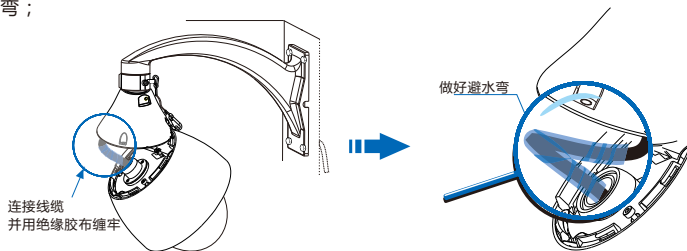

5. 务必将线缆整理好并用束带捆绑住，束带穿过束带固定件并拉紧束带；

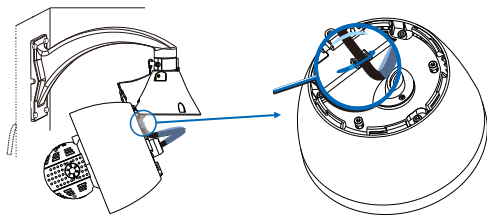

- 盖扣上球罩并拧紧上球罩上两颗固定螺钉；
- 装套防护罩：对接紧密对开式防护罩后，对齐球罩上圆点，旋转至标签对齐，拧紧对开式防护罩上的螺钉。

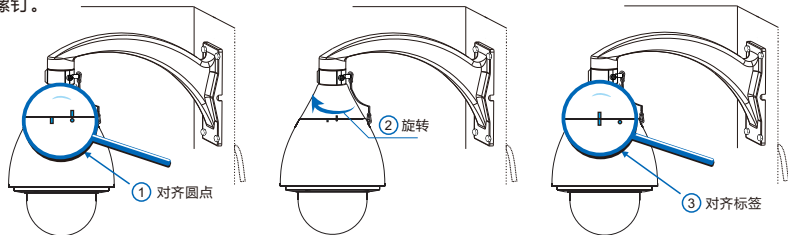

## 室内球安装

【注意】请在安装步骤全部完成之后再撕去镜头前的保护膜。

### 嵌入式安装

【说明】嵌入式支架为选配配件。

- 装配支架，将球机与支架安装至一体：对准出线孔，用螺钉固定支架；
- 根据贴纸上尺寸及摄像机尺寸确定合适安装位置后，将安装辅助贴纸贴在天花板上，开出相应孔洞；建议天花板开孔尺寸为 $\varnothing 208\text{mm} \sim \varnothing 211\text{mm}$ ，且吊顶与天花板之间的距离至少为 $150\text{mm}$ ；
- 按球罩上所贴标签连接线缆，连接完成后检查并整理各类线缆，然后用绝缘胶布缠绕牢固；
- 请将线缆整理好并用束带捆绑住，束带穿过束带固定件并拉紧束带；

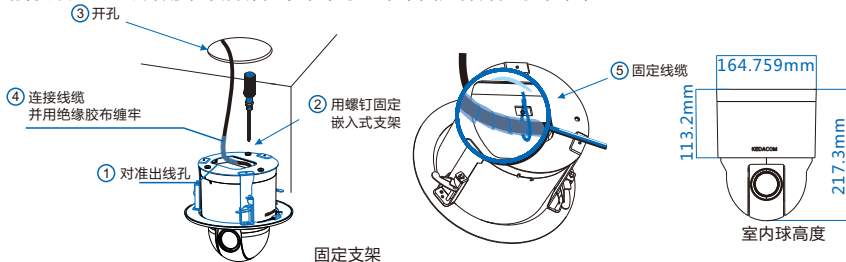

5. 将设备推入孔洞中，调整至合适位置后锁紧螺钉使支撑片夹紧天花板；

**【说明】**按照支架上所贴标签的指示调整支架方向，最终让标签中的箭头对准监控区域的中间位置。

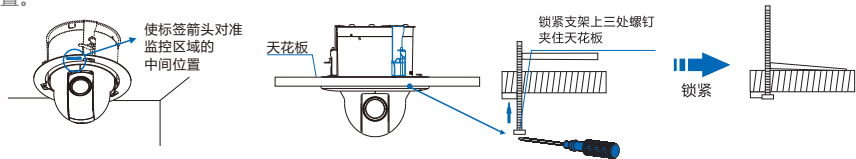

6. 安装饰裙边。

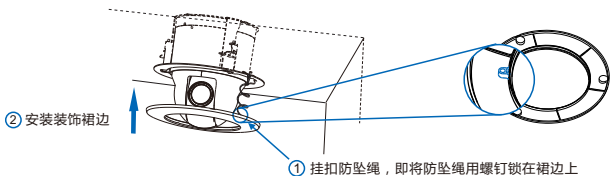

## 吸顶式安装

1. 确定安装位置后，安装底座转接盘和球机底部螺丝；

**【说明】**安装辅助贴纸上标有安装方向，请根据安装环境注意调整安装辅助贴纸粘贴角度，使贴纸上箭头标识的方向对准监控区域。

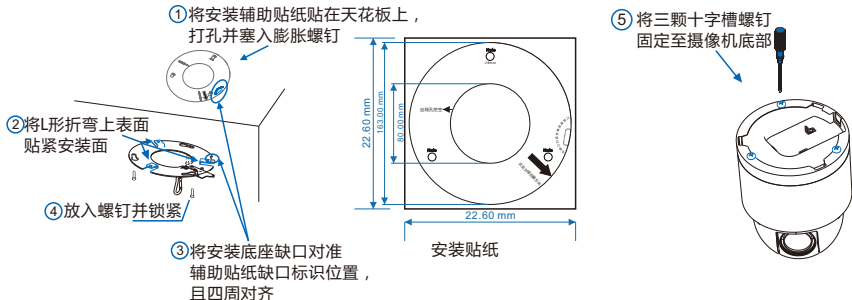

2. 将防坠绳扣至摄像机上；
3. 按球罩上所贴标签连接线缆，连接完成后检查并整理各类线缆，然后用绝缘胶布缠绕牢固；
4. 请将线缆整理好，使之不要高出摄像机顶部安装面；
  - 顶部出线：必须在安装面上预留线孔（根据安装贴上标识的开口尺寸开孔），将尾线引出即可。
  - 侧面出线：用老虎钳在底座钳开出线孔，将尾线引出即可。

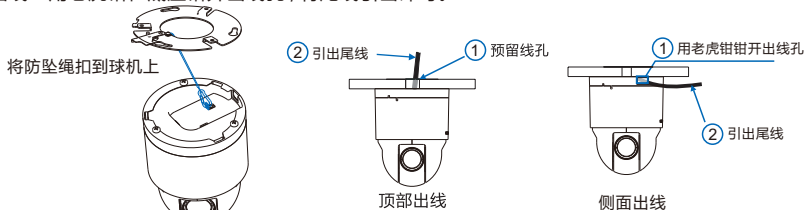

5. 完成底座安装及其处理好线缆后，将摄像机装配至安装底座，务必最后锁紧弹片。

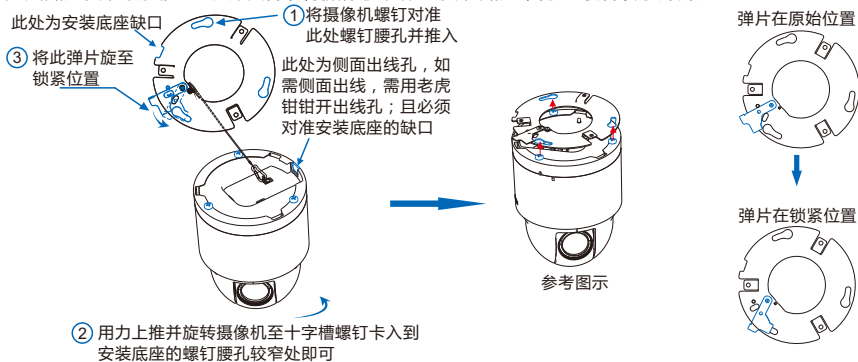

## 设备上电

- 安装完成后，请再次检查，确保室外球密封。
- 设备上电，并使用IPCSearch进行初始配置和登录。
- 摄像机配置请参考其用户手册。

## 附录1 拨码开关



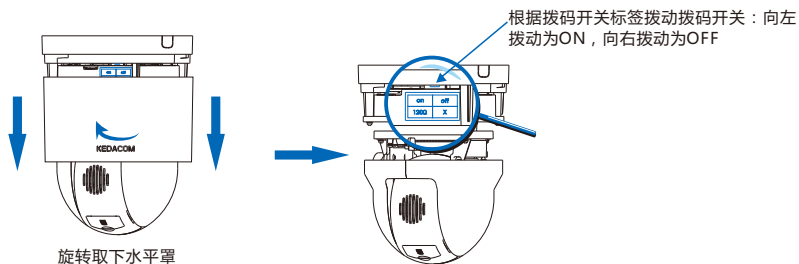





为了提高RS485总线的可靠性和通讯质量，若总线两端的设备需要接120欧姆电阻，需将设备拨码开关拨到ON。



【说明】仅适用于带拨码开关标签的型号。

## 附录2 线缆识别

线缆识别1					
线序	标签标示	颜色		组别	注释
1	RS485_A		黑	一组	RS485串口A
2	RS485_B		红		RS485串口B
3	AUDIO_IN		灰		音频输入
4	AUDIO_OUT		黄		音频输出
5	AUDIO_GND		蓝		音频接地
6	ALARM_IN 1		白	一组	告警输入1
7	ALARM_IN 2		紫		告警输入2
8	ALARM_IN 3		橙		告警输入3
9	ALARM_IN 4		棕		告警输入4
10	ALARM_IN_GND		绿		告警输入接地
11	ALARM_OUT 1A		黑/白	一组	告警输出1，两个端子不分正负
12	ALARM_OUT 1B		红/白		
13	ALARM_OUT 2A		粉红		告警输出2，两个端子不分正负
14	ALARM_OUT 2B		棕/白		
15	Reserved		紫/白		悬空保留

线缆识别2					
线序	标签标示	颜色		组别	注释
1	AUDIO_IN		红	一组	音频输入
2	AUDIO_OUT		灰		音频输出
3	AUDIO_GND		黑		音频接地
4	ALARM_IN 1		蓝	一组	告警输入1
5	ALARM_IN 2		白		告警输入2
6	ALARM_IN_GND		黄		告警输入接地
7	ALARM_OUT 1A		紫		告警输出1，两个端子不分正负
8	ALARM_OUT 1B		绿		

- 【说明】** 1.不同子型号线缆规格有区别，请用户根据线缆数量参照上表进行识别。  
2.电源AC 24V和电源接地，在电源线标签上有标示。

## 保修说明

本保修卡适用于您购买的本公司系列产品。

1.终身保质，免费保修期一年（仅限中国大陆地区，中国大陆以外地区请参考英文说明）。

2.凡保修期内，由于本产品自身引起的故障，请与公司售后服务部联系。

3.保修时我们将使用您的保修卡信息，请认真填写。

4.以下情况，属于有偿保修范围：

- 人为原因造成的设备故障
- 因使用环境不符合本产品要求造成的故障
- 因不可抗力造成的产品损坏
- 无保修卡
- 已过保修期

## 用户信息

用户名称：

详细地址：

传真：

电话：

邮箱：

邮编：

产品名称：

产品型号：

购买日期：

## Preface

Thank you for purchasing our product. If there are any questions, or requests, please do not hesitate to contact us.

Every effort has been made to ensure the accuracy and validity of this Guide. Any update of this Guide is subject to change without notice. For the latest document, please contact the dealer.

## Safety Instruction

These instructions are intended to ensure that the user can use the product correctly to avoid danger or property loss. Please read this Guide carefully before using the product, and keep it properly for future reference. If the product cannot work normally or is damaged because the user does not follow the safety instructions, we shall not assume any responsibility.

- Please adopt power supply in the safety voltage range: AC24V, 2.5A.
- If the product does not work properly, please contact your dealer or the nearest service center. Never attempt to disassemble or repair the product yourself in any way.
- Do not drop the camera or subject it to physical shock.
- When cleaning the lens, please use a rubber dust blower or lens cleaning cloth to remove the dirt. When cleaning transparent housing, please use soft and dry cleaning cloth to wipe it gently. Never apply any cleanser with ethanol or benzene in it.
- Do not focus the camera lens on strong light such as the sun or incandescent lamp. The strong light can cause overexposure or light leak (not camera malfunction), which may shorten camera lifetime.
- Do not expose the camera in the environment not defined in the Guide.
- Keep the camera away from water or any liquid.
- While shipping the camera, pack it in the factory packing or use materials with equivalent quality.
- When it is necessary to replace a part, please contact your dealer in advance and replace the part with specified model or part of the same features. We shall not assume any responsibility for problems caused by unauthorized replacement.

## Waterproof

- For outdoor mounting, suggest applying wall mounting bracket whose beam has an upward angle.
- If user uses self-selected bracket, suggest applying those waterproof brackets with female screw thread connector. If user selects brackets with male screw thread, make sure of the waterproof ness of the connecting part between the bracket and the high speed dome camera.
- The screw thread connector needs to be bound with thread seal tape to ensure the sealing tightness of screw thread. When mount, align with the screw thread to avoid obvious deviation or slipping.
- The O-ring seal for the transparent housing of dome camera must be mounted to prevent vapor or dust penetration.



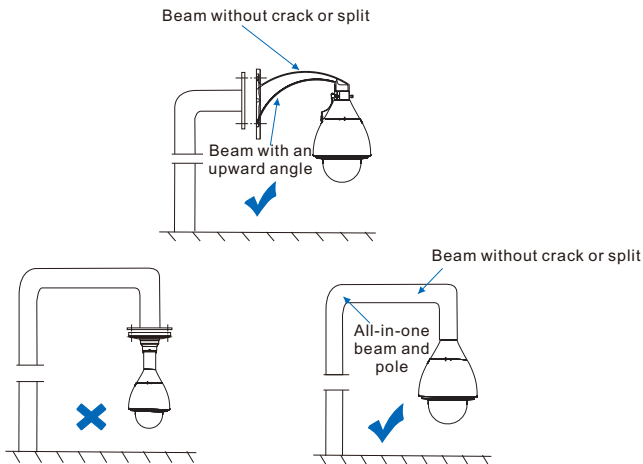

### **Anti-static, Anti-interference, Anti-thunder, Anti-surge**

- The camera should be grounded, or ESD may damage the electrical parts.
- In thunder and lightning area, camera should be grounded nearby to release the heavy energy of thunder strike so as to prevent camera from damage.
- In area with unstable voltage, camera should be grounded to release the heavy energy of electrical surge so as to prevent power source from burning.
- Camera anti-thunder ground lead cannot replace safety ground lead. When apply poles with imperfect earth, such as wooden pole and cement pole, camera should connect the safety ground lead to release leak current so as to ensure the safety of camera or pole.
- Camera anti-thunder ground lead must be grounded individually, other than being grounded through other electrical device nearby.

### **[Cement Pole Ground]**

Cement pole mounting needs protective steel pipe to lead the ground wire. As the picture shows, the ground wire of high speed dome camera goes through the steel pipe and grounds. The Command Center just has to ground locally according to the norms.

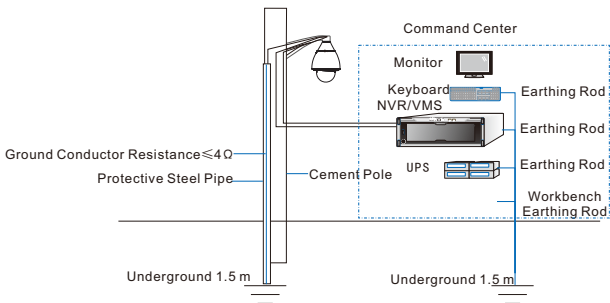

Cement Pole Ground

### [Metal Pole Ground]

Metal pole mounting needs PVC pipe to lead the ground wire. Metal pole without lightning rod applies PVC pipe to lead ground wire. Fix the ground wire near the metal pole and ground it, as the picture shows.

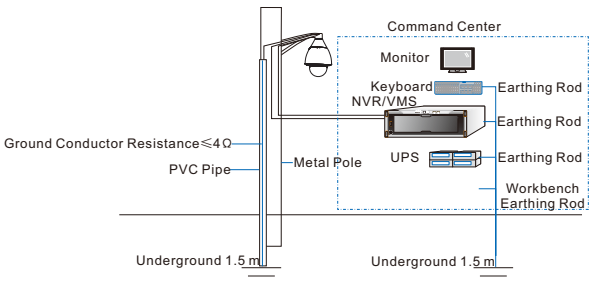

Metal Pole Ground

Metal pole with lightning rod applies inside PVC pipe to lead ground wire, and the PVC pipe should keep an insulation distance from the inner wall of metal pole as far as possible, as the picture shows.

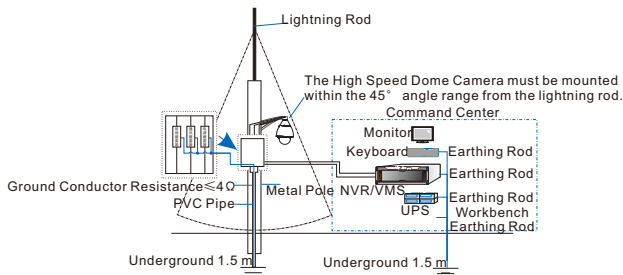

**[Note]:** If there is middleware installed, such as optical transceiver or anti-thunder device, the middleware should be well grounded and the camera should also be well grounded if the cable goes through the middleware.

**[Attention]:** Please follow the steps as described in this guide when install the camera. User should take the responsibility for improper installation caused by operation not defined in this guide.

## Installation Inspection

- Before installation, inspect the strength of the installation wall or ceiling.
- The wall or ceiling should be thick enough to support anchoring.
- The wall or ceiling should be able to hold weight 8 times of the total weight of the dome camera and the accessories such as the bracket.

The maximum net weight of the outdoor dome camera is 4.5 kg and that of the indoor dome camera is

## Dome Camera Preparation

1. Open the transparent housing of dome camera, take out the anti-vibration sponge, peel off the protective sticker on the housing and insert a SD card if necessary.

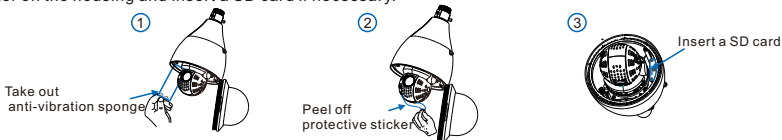

**[Note]:** The SD card slot location of some models is different from that on the picture. Please install according to actual cameras.

2. Cover the housing and tighten the screws.

**[Note]:** The bottom of the housing is easy to be scratched. Please peel off the protective film after all the steps are finished.

## Outdoor Dome Camera Installation

### Wall Mounting

1. Lead the cable through the bracket with an extra length for connecting with the internal wire of the dome camera (20 cm to 30 cm recommended);
2. Drill holes in the wall according to the installation sticker, insert anchoring, align the holes on the holder to the holes on the wall, insert screws and tighten up;

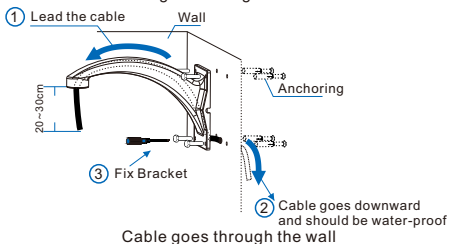
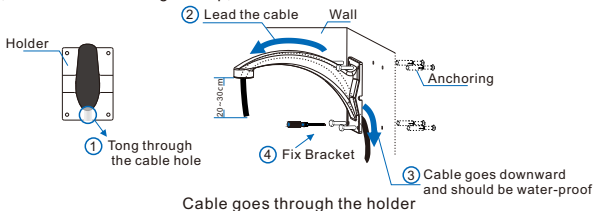

3. Bind thread seal tape around the screw thread part of the connector, screw up the connector onto the bracket and tighten the screws on the bracket. Make sure that the anti-off screw on the connector is loose. Take out the hook and hang it on the hanger of the connector.

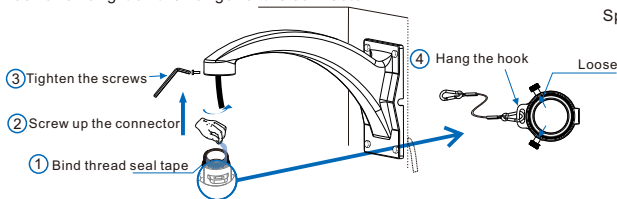

Specifications of the connector:

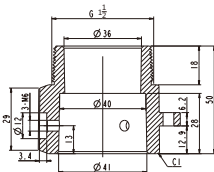

## Other Bracket Mounting

Steps to install the connector are the same as that of wall mounting.

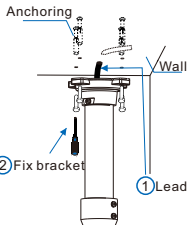

Ceiling Bracket Mounting

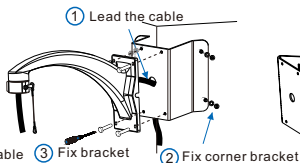

Corner Bracket Mounting

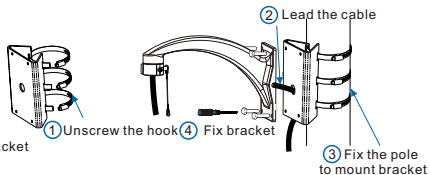

Pole Bracket Mounting

[Note]: All brackets are optional.

## Outdoor Dome Camera Installation

1. Twist off the screw on the housing, rotate as the sticker indicates and split the housing round about;

[Note]: Split housing has an internal anti-drop wire connecting with the dome camera. The following is just a schematic installation diagram.

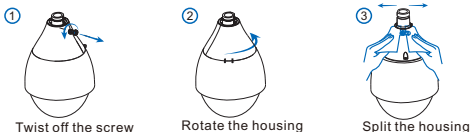

2. Hang the safety hook and lead the cable through the upper housing. Align the straight side of D-shaped head to connector sticker, then push the head till the end, and rotate to fix the dome camera. Tighten the screws on the connector;

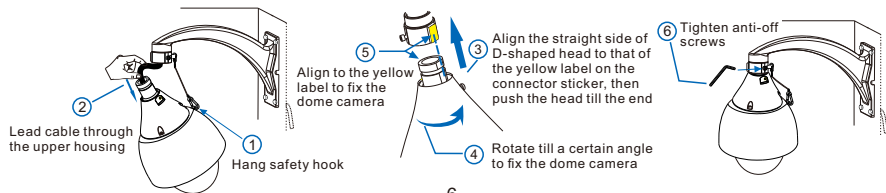

3. Twist off the 2 positioning screws on the upper housing and open the upper housing;

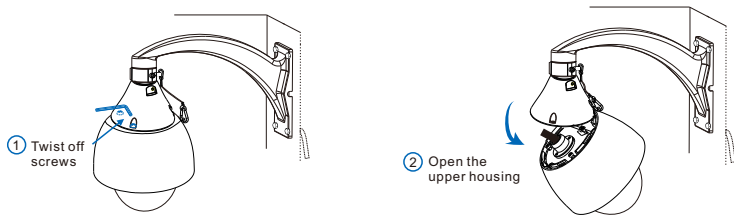

4. Connect cables as the sticker in the dome camera indicates. Afterwards, examine and sort all cables, tighten them with insulating tape and make a water-proof curve;

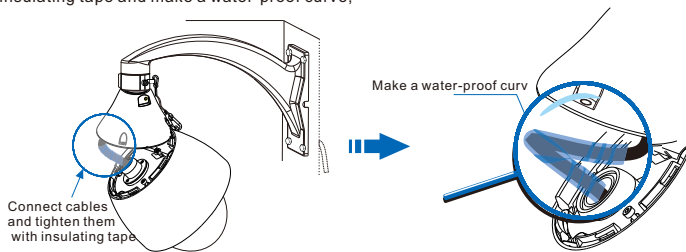

5. Make sure that cables are well sorted and bound. Lead the bound cables through the positioning part and pull them tight;

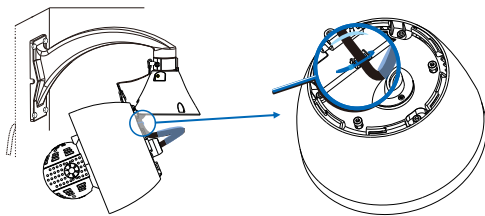

- Cover and lock the upper housing tight with 2 positioning screws;
- Install the housing: connect the split housings tight, align the dot on the housing, rotate it to align with the sticker, and tighten the screws on the split housings.

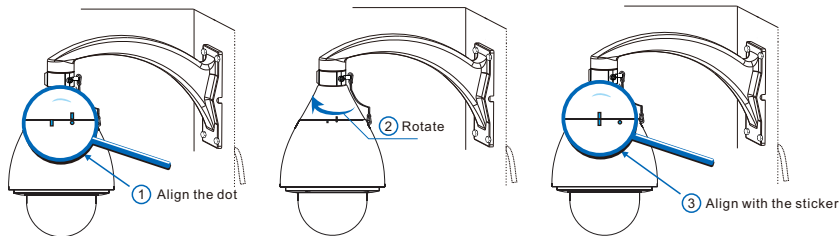

## Indoor Dome Camera Mounting

**[Attention]:** Please peel off the protective film covering the lens after all installations are completed.

### Embedded Mounting

**[Note]:** All embedded brackets are optional.

- Mount the bracket, and assemble the camera and the bracket: align the cable holes and fix the bracket with screws;
- According to the size on the sticker and the size of camera, find proper installation position, paste the sticker on the suspended ceiling, and drill holes; suggested hole size:  $\varnothing 208\text{mm} \sim \varnothing 211\text{mm}$ , min distance between the ceiling and the suspended ceiling is 150mm;
- Connect cables as the sticker indicates. Afterwards, examine and sort all cables, and tighten them with insulating tape;
- Make sure that cables are well sorted and bound. Lead the bound cables through the fixture and pull them tight;

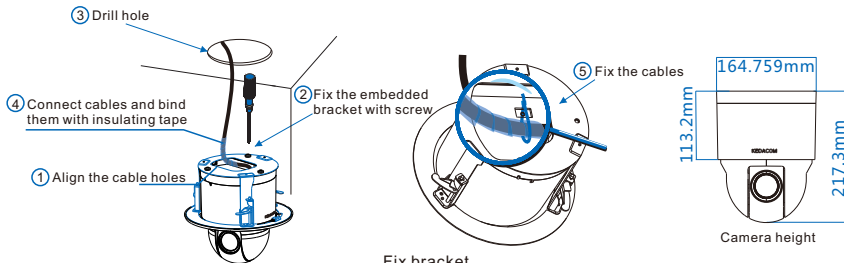

- Push the camera into the cable hole, adjust it to a suitable position and tighten the screws to make sure the supporting plate clamps the suspended ceiling tight;

**[Note]:** Adjust bracket as the sticker indicates and point the arrow on the sticker to the center of the area.

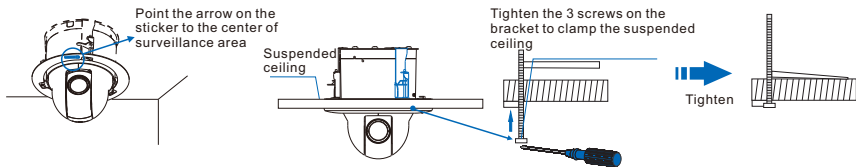

- Install the trim ring.

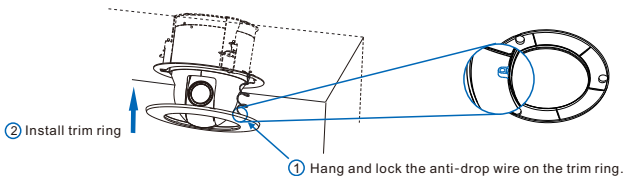

## Ceiling Mounting

- After confirm the mounting position, install the base adaptor and the screws at the bottom of camera;

**[Note]:** The installation direction is indicated on the sticker. Please stick the installation sticker according to the scene and point the arrow on the sticker to the surveillance area.

- Paste the sticker on the suspended ceiling, drill holes and insert anchoring screws

- Put the upper surface of L-shape bender close to the mount surface

- Insert and tighten screws

- Align the gap on the base to the mark on the sticker

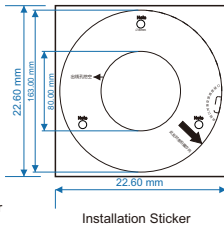

- Fix the 3 Philips screws to the bottom of camera

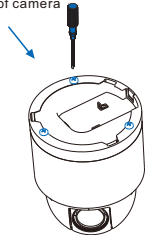

- Hang the anti-drop wire on the camera;
- Connect cables as the sticker indicates. Afterwards, examine and sort all cables, and tighten them with insulating tape;



4. Sort the cables well and make sure that they do not exceed the mount surface on the top of the camera;
- Top cabling: must retain a cable hole on the mount surface (drill holes according to the size indicated on the sticker), and lead the tail cable out.
  - Side cabling: drill a cable hole on the holder with pincer pliers, and lead the tail cable out.

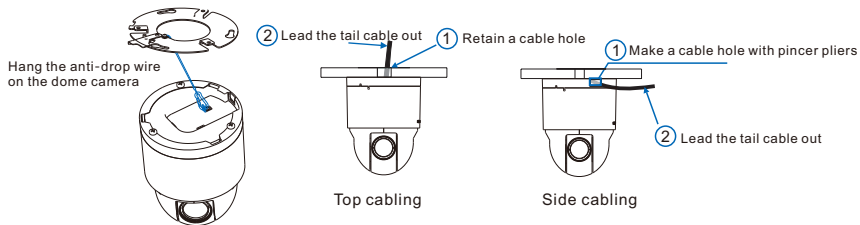

5. After base installation and cable sorting, assemble the camera to the base and lock the shrapnel tight.

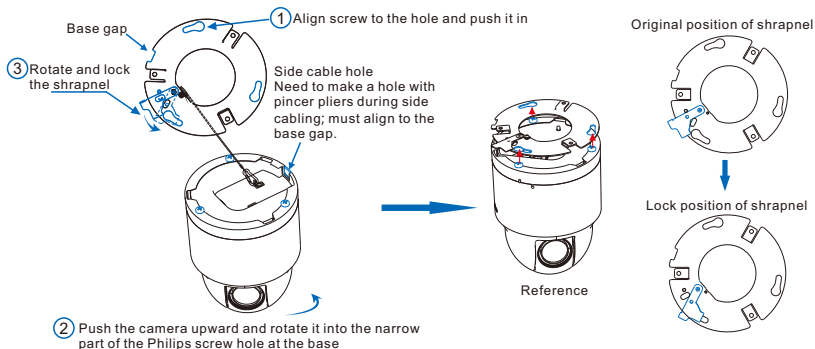

## Power on

- After installation, please inspect again to ensure the sealing of dome camera.
- Power on the camera, use IPCSearch to operate initial configuration and login.
- Please refer to the *User Manual* for camera configuration.

## Appendix 1 Toggle Switch

To improve the reliability and communication quality of RS-485 cable, when the device at the ends of the cable connects to 120Ω resistor, dial the toggle switch to “ON”.

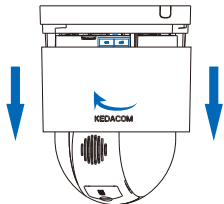





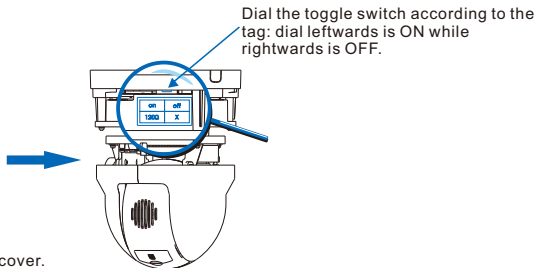

















Rotate to take apart the horizontal cover.

[Notice]: Applicable only to models with toggle switch tags.



## Appendix 2 Cable Identification

Cable Identification 1					
Sequence	Tag	Color		Group	Remarks
1	RS485 A		Black	One Group	Rs485 Serial Port A
2	RS485 B		Red		Rs485 Serial Port B
3	AUDIO_IN		Gray		Audio Input
4	AUDIO_OUT		Yellow		Audio Output
5	AUDIO_GND		Blue		Audio Grounding
6	ALARM_IN 1		White	One Group	Alarm Input 1
7	ALARM_IN 2		Purple		Alarm Input 2
8	ALARM_IN 3		Orange		Alarm Input 3
9	ALARM_IN 4		Brown		Alarm Input 4
10	ALARM_IN_GND		Green		Alarm Input Grounding
11	ALARM_OUT 1A		Black/White	One Group	Alarm Output 1, regardless of positive and negative
12	ALARM_OUT 1B		Red/White		
13	ALARM_OUT 2A		Pink		Alarm Output 2, regardless of positive and negative
14	ALARM_OUT 2B		Brown/White		
15	Reserved		Purple/White		

Cable Identification 2					
Sequence	Tag	Color		Group	Remarks
1	AUDIO_IN		Red	One Group	Audio Input
2	AUDIO_OUT		Gray		Audio Output
3	AUDIO_GND		Black		Audio Grounding
4	ALARM_IN 1		Blue	One Group	Alarm Input 1
5	ALARM_IN 2		White		Alarm Input 2
6	ALARM_IN_GND		Yellow		Alarm Input Grounding
7	ALARM_OUT 1A		Purple		Alarm Output 1, regardless of positive and negative
8	ALARM_OUT 1B		Green		

### [Notice]:

1. Different sub-models may have different cables. Please refer to the above table to identify cables according to the cable quantity.
2. AC 24V power line and the ground wire are marked on the tags of power cord.

## **Kedacom Two (2) Year Limited Hardware Warranty**

### **WHAT IS COVERED BY THIS WARRANTY?**

Kedacom warrants the Kedacom-branded hardware product and accessories contained in the original packaging (hereinafter referred to as "Kedacom Product") against defects in materials and workmanship when used normally in accordance with Kedacom's published guidelines for a period of TWO (2) YEARS from the date of original retail purchase in areas other than mainland China by the end-user purchaser (hereinafter referred to as "Warranty Period"). For the Kedacom Product purchased in mainland China, see the simplified Chinese version of this warranty for details. Kedacom's published guidelines include but are not limited to information contained in technical specifications, user guides, and service communications. The preceding applies unless otherwise agreed in the contract.

### **WHAT IS NOT COVERED BY THIS WARRANTY?**

This warranty does not apply to any non-Kedacom branded hardware products or any software, even if packaged or sold with Kedacom hardware. Manufacturers, suppliers, or publishers, other than Kedacom, may provide their own warranties to you but Kedacom, in so far as permitted by law, provides their products "AS IS". Software distributed by Kedacom with or without the Kedacom brand (including, but not limited to system software) is not covered by this warranty. Please refer to the licensing agreement accompanying the software for details of your rights with respect to its use. Kedacom does not warrant that the operation of the Kedacom Product will be uninterrupted or error-free. Kedacom is not responsible for damage arising from failures to follow instructions relating to the Kedacom Product's use.

This warranty does not apply: (a) to consumable parts, such as batteries, unless failure has occurred due to a defect in materials or workmanship; (b) to cosmetic damage, including but not limited to scratches, dents, and broken plastic on ports; (c) to damage caused by use with another product; (d) to damage caused by acts outside the control of Kedacom, including without limitation acts of God, accidents, abuse, misuse, fire, storms, earthquakes, flood, or other external cause; (e) to damage caused by exposure of the product to heat, bright light, sun, liquids, sand, or other contaminants; (f) to damage caused by operating the Kedacom Product outside Kedacom's published guidelines; (g) to damage caused by service (including upgrades and expansions) performed by anyone other than a representative of Kedacom, Kedacom employee, or authorized Kedacom agent; (h) to an Kedacom Product that has been modified to alter functionality or capability without the written permission of Kedacom; (i) to defects caused by normal wear and tear or otherwise due to the normal aging of the Kedacom Product, or (j) if any serial number has been removed or defaced from the Kedacom Product.

### **YOUR RESPONSIBILITIES**

If your Kedacom product is capable of storing data and other information, you should make periodic backup copies of the information contained on the storage media to protect the contents and as a precaution against possible operational failures.

Before receiving warranty service, Kedacom or its authorized agents may require that you furnish proof of purchase details, respond to questions designed to assist with diagnosing potential issues, and follow Kedacom's procedures for obtaining warranty service. Before submitting your Kedacom Product for warranty service, you should maintain a separate backup copy of the contents of its storage media, remove all personal information that you want to protect, and disable all security passwords.

During warranty service, it is possible that the contents of the Kedacom product's storage media will be lost, replaced or reformatted. In such an event, Kedacom and its authorized agents are not responsible for any loss of data or other information contained on the storage media or any other part of the Kedacom product serviced.

Following warranty service, your Kedacom Product or a replacement product will be returned to you as your Kedacom Product was configured when originally purchased, subject to applicable updates. You will be responsible for reinstalling all other data and information. Recovery and reinstallation of other data and information are not covered under this warranty.

### **WHAT WILL KEDACOM DO IF THE WARRANTY IS BREACHED?**

If during the Warranty Period, you submit a valid claim to Kedacom or an authorized Kedacom agent, Kedacom will, at its option, (i) repair the Kedacom Product using new or previously used parts that are equivalent to new in performance and reliability, or (ii) exchange the Kedacom Product for a refund of your purchase price.

A Kedacom replacement part or product, including a user-installable Kedacom part that has been installed in accordance with instructions provided by Kedacom, assumes the remaining warranty of the Kedacom Product or ninety (90) days from the date of replacement or repair, whichever provides longer coverage for you. When a product or part is replaced or a refund provided, any replacement item becomes your property and the replaced or refunded item becomes Kedacom's property.

Kedacom reserves the right to refund the purchase price as its exclusive warranty remedy.

### **HOW TO OBTAIN WARRANTY SERVICE?**

To seek warranty service, please contact a local authorized Kedacom agent. When contacting the agent via telephone, other charges may apply depending on your location.

### **User Information**

Complete the form below and keep for ready reference.

User Name:	
Address:	Postal Code:
Tel:	Mobile:
Fax:	E-Mail:
Product Name:	Product Model:
Date of Purchase:	





客户咨询热线 : **800-828-2866**    **400-828-2866**

**Overseas Hotline: +86-0512-8896 9861**

**KEDACOM**

**苏州科达科技股份有限公司**

Suzhou Keda Technology Co.,Ltd.

中国: 江苏省苏州市高新区金山路131号(215011)

Tel: +86-512-68418188    Fax: 86-512-68412699

Suzhou Keda Technology Co.,Ltd.

Singapore: 627A Aljunied Road, #09-07, BizTech Centre, Singapore 389842

Tel: +65-6842-5700    Fax: +65-6842-5900